

	ITEM: #		Our item #:	3220W
--	---------	--	-------------	--------------

Description:	Wilson Royale Umpire Chair, All hardware Stainless Steel	Date: 11-17-10	
--------------	---	----------------	--

LEGS
Part #3572W A
 Left Front Leg
 (#1 = red dot)

Part #3572W B
 Left Back Leg
 (#2 = yellow dot)

Part #3572W C
 Right Front Leg
 (#3 = blue dot)

Part #3572W D
 Right Back Leg
 (#4 = green dot)

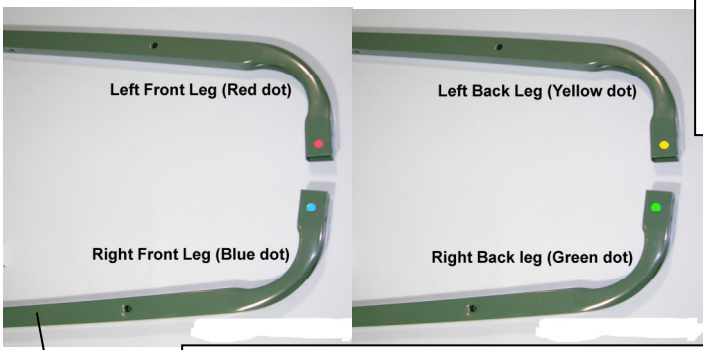

1 = #3572W A = Left Front Leg (Red dot)
 2 = #3572W B + Left Back Leg (Yellow dot)
 3 = #3572W C = Right Front Leg (Blue dot)
 4 = #3572W D = Right Back Leg (Green)



There are 2 ways to identify the legs. One is by the color of the dot (see above). The other is by the number of holes and their location on the legs. On the left front (LF) leg #3572W A and right front (RF) leg #3572W C, the 5 holes for the front steps and shelf/platform are not centered on the leg but are to the inside of the chair. Similarly, on the left back (LB) leg #3572W B and right back (RB) leg #3572W D, the one hole for the shelf/platform is not centered on the leg but rather is to the inside of the chair. Make sure you have properly identified all 4 legs so that their holes will be toward the inside when installed.

Part #3558W
 (Top)
 Back Seat Board For Umbrella

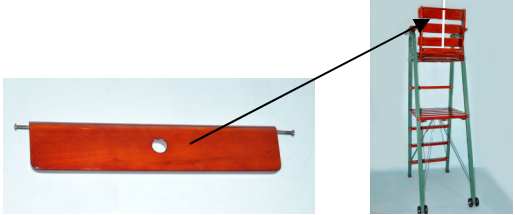

Install to top of chair back using bolts provided. Slide bolts through hole on seat back (part #3562W) and into Part #3558W to secure.

Part #3559W
 (Bottom)
 Back Seat Board For Umbrella

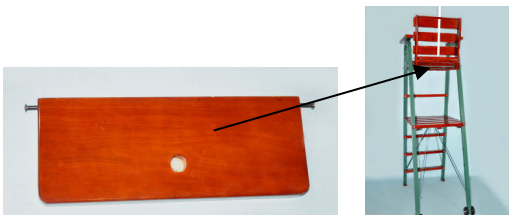

Install to bottom of chair back using bolts provided. Slide bolts through hole on seat back (part #3562W) and into Part #3559W to secure.

Part #3560W
 Wooden Block that Connects Steel Legs

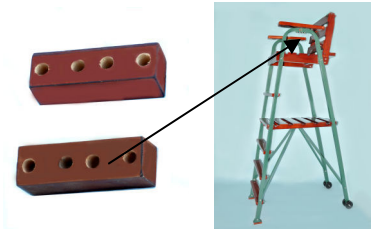





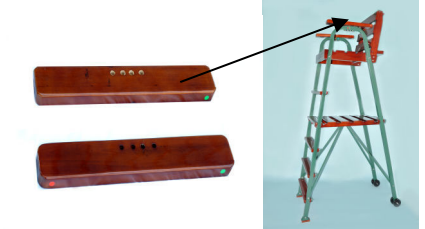

Wooden Block with 4 holes that connects steel legs at top. Size: L 4 5/16" x W 1 1/4" x D 1 1/4". #3560W refers to one block. If you need two blocks, order 2 - #3560W.

Part #3561W
 Chair Arm

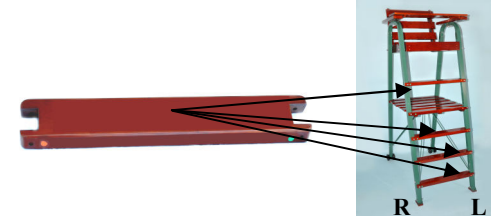
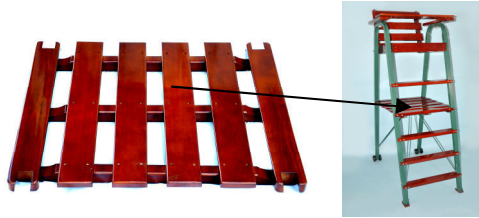
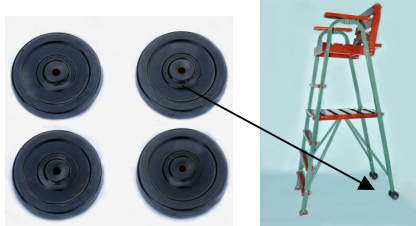
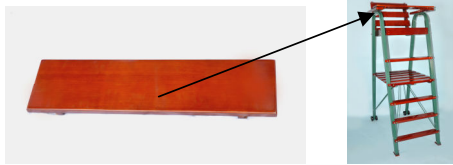

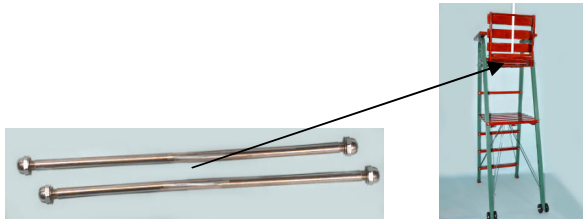
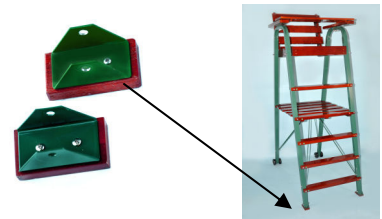
L 20" x W 3 5/16" X D 1 1/2". These are the chair arms with grooves for the writing desk. Grooves must be to inside when putting arms on.

<p>Part #3562W Back of Seat</p>		
<p>Part #3563W Seat Bottom</p>	 <div data-bbox="1062 424 1398 575" style="border: 1px solid black; padding: 5px;"> <p>Under side of Seat shown with Axel Rods (Part #3569W).</p> </div>	
<p>Part #3564W Step</p>	 <div data-bbox="873 655 1398 844" style="border: 1px solid black; padding: 5px;"> <p>#3564W refers to one step. If you need 4 steps, order 4 - #3564W. Step is facing out when green dot is on right side and red dot is on left.</p> </div>	
<p>Part #3565W Shelf/Foot Platform</p>		
<p>Part #3566W Rubber Wheel</p>	 <div data-bbox="824 1171 1349 1314" style="border: 1px solid black; padding: 5px;"> <p>Rubber wheel, 3 1/2" dia x 1" H. #3566W refers to one wheel. If you need four wheels, order 4- #3566W.</p> </div>	
<p>Part #3567W Writing Desk</p>	 <div data-bbox="919 1440 1224 1521" style="border: 1px solid black; padding: 5px;"> <p>L 28 1/2 " x W 7 1/2 " x D 1"</p> </div>	
<p>Part #3568W Flat Steel Leg Support</p>	 <div data-bbox="959 1615 1341 1776" style="border: 1px solid black; padding: 5px;"> <p>#3568W refers to one support. If you need four supports, order 4- #3568W.</p> </div>	
<p>Part #3569W Seat Support Rod</p>	 <div data-bbox="943 1897 1398 2010" style="border: 1px solid black; padding: 5px;"> <p>#3569W refers to one axel rod. If you need two, order 2- #3569W.</p> </div>	
<p>Part #3570W Foot</p>	 <div data-bbox="894 2166 1349 2268" style="border: 1px solid black; padding: 5px;"> <p>#3570W refers to one foot. If you need two feet, order 2- #3570W.</p> </div>	
<p>Part #3571W Bag of Hardware</p>		

PACKING LIST:

3220W

The umpire chair parts #'s refer to a single part only. Example: #3568W refers to one support. If you need 4 supports, you must order 4/ #3568W. This is also true for parts #3564W, #3670W, #3560W, #3566W and #3569W.

Leg dots right & left are from the perspective of someone sitting in the chair.

BOX A

Box A Dimensions: 28-1/2"L x 27"W x 8-1/2"H G.W. 46 lbs. Total pieces: 8

7

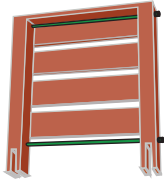

Part #3563W Seat Bottom 1PC

8

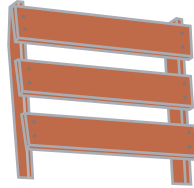

Part #3562W Back of Seat 1PC

9



Part #3564W Step
Need 4 pcs per chair

12

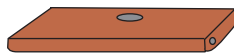

Part #3558W Back of Seat Top
Board for Umbrella 1PC

13

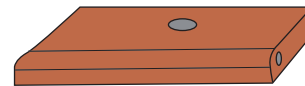

Part #3559W Back of Seat Bottom
Board for Umbrella 1PC

BOX B

Box B Dimensions: 34"L x 27"W x 4"H G.W. 31 lbs. Total pieces: 6

6

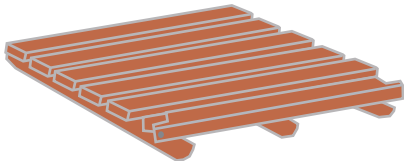

Part #3565W Shelf/Foot Platform 1PC

10

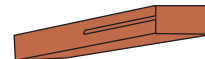

Part #3561W Chair Arm (grooves face inside)
Need 2 pcs per chair

11



Part #3567W Writing Desk 1PC

15

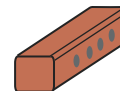

Part #3560W Wooden Block that connects Steel Legs
Need 2 pcs per chair

BOX C

Box C Dimensions: 88"L x 9-1/2"W x 4"H G.W. 45 lbs. Total pieces: 17

1



Part #3572W A Left Front Leg (red dot) 1PC

2



Part #3572W B Left Back Leg (yellow dot) 1PC

3



Part #3572W C Right Front Leg (blue dot) 1PC

4



Part #3572W D Right Back Leg (green dot) 1PC

5



Part #3568W Flat Steel Support For Legs
Need 4 pcs per chair

14



Part #3570W Foot
Need 2 pcs per chair

16

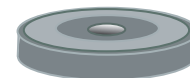

Part #3566W Rubber Wheel
Need 4 pcs per chair

17

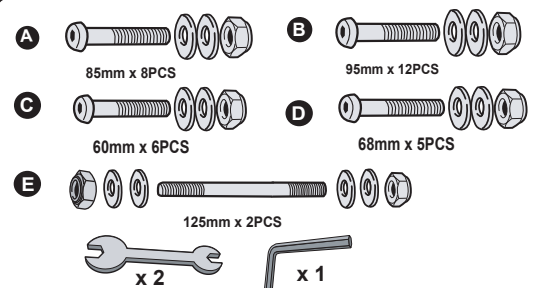

Part #3571W Bag of Hardware

18

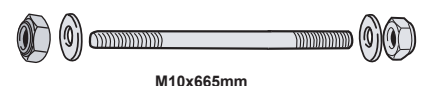

Part #3569W Seat Support Rod
Need 2 pcs per chair

STEP 1: Attach legs and arms

Lay out the 4 legs (Parts 1-4) following color and hole locations guidelines. Assemble front and back legs on each side, with wooden block (Part 15) fitting into legs' top square hollow ends and attaching chair arm (Part 10) with 85mm bolt, washers and nut (Part A). Loosely tighten screws by hand only. See drawing #1.

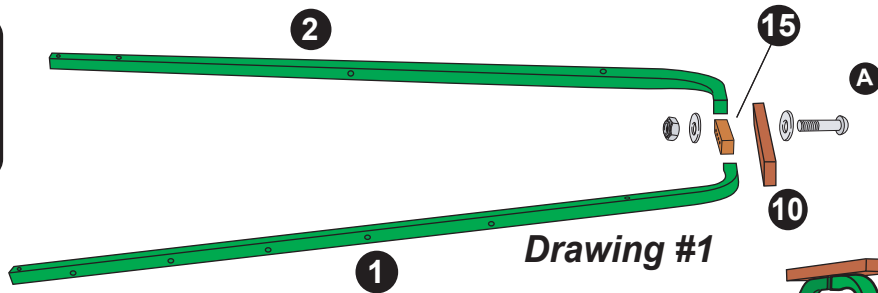
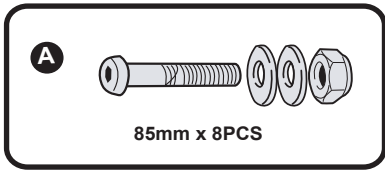

STEP 2: Attach shelf/platform

Attach shelf/foot platform (Part 6) to left and right legs at front and back using 95mm bolts, washers and nuts (Part B). Loosely tighten screws by hand only. See drawing #2.

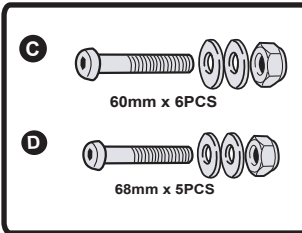
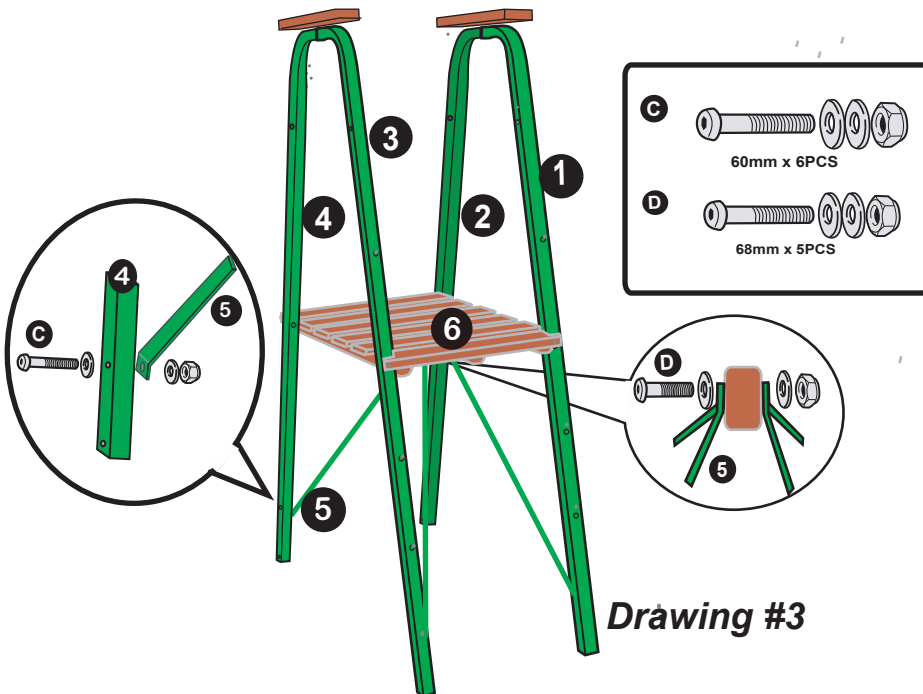
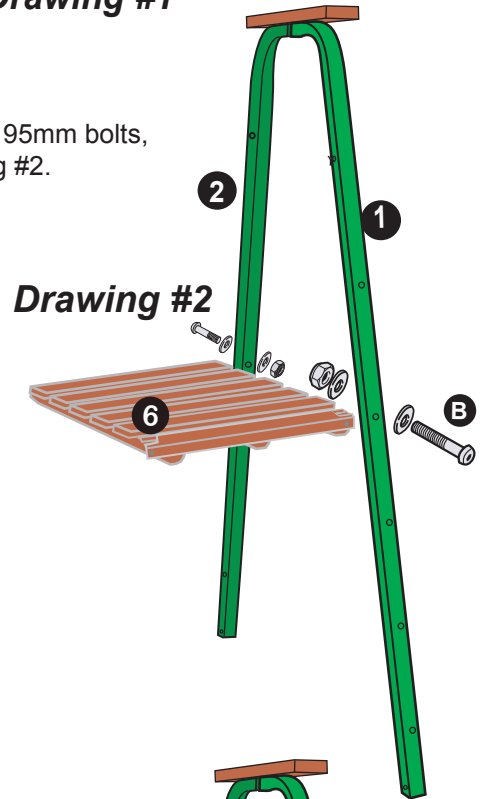
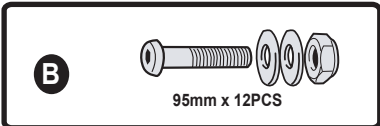

STEP 3—Attach leg supports

Before attaching seat and steps to legs, attach the 4 flat steel leg supports (Part 5) to bottoms of legs using 60mm bolts, washers and nuts (Part C) and to the middle brace of shelf/foot platform using 68mm bolts, washers and nuts (Part D). Again, loosely tighten screws by hand only. See drawing #3.

STEP 4—Attach steps

Attach the 4 steps (Part 9) to front right and left legs using 95mm bolts, washers and nuts (Part B). Three steps are attached below the shelf/foot platform and one step is attached above. Again, loosely tighten screws by hand only. See drawing #4.

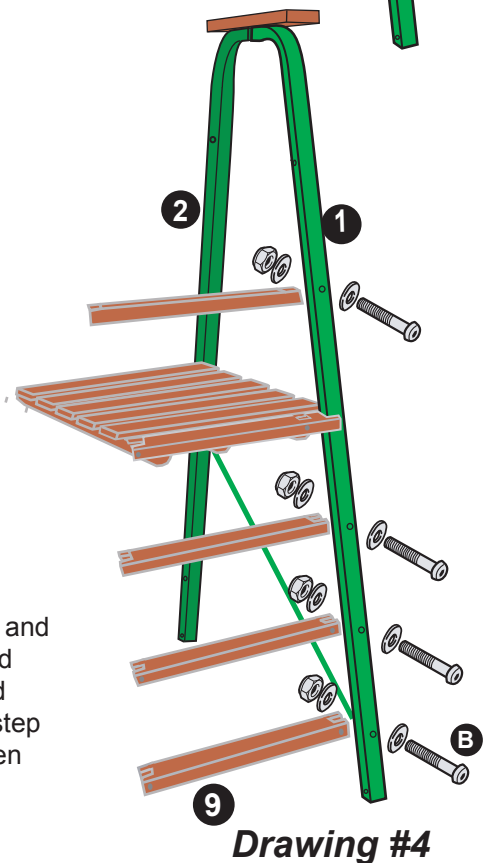

STEP 5—Attach seat bottom

To attach seat bottom (Part 7), first slide 665mm support rods (Part 18) through green tubes underneath seat bottom. Then attach support rods to left and right legs at front and back using washers and screws. Loosely tighten screws by hand only. See drawing #5.

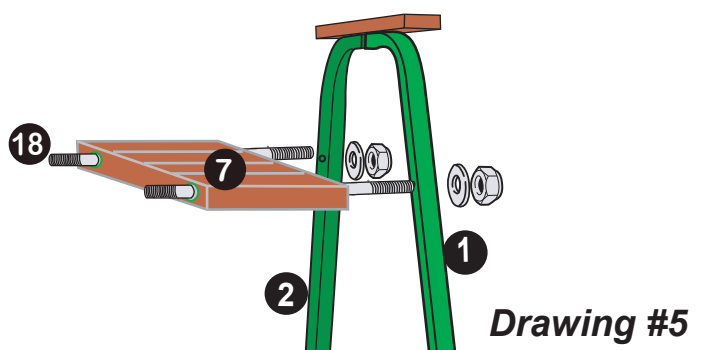
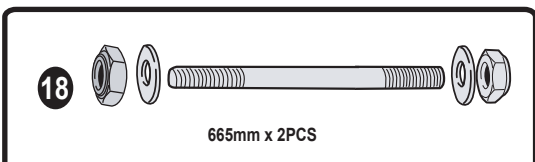

STEP 6: ATTACH SUPPORT BOARDS FOR OPTIONAL UMBRELLA



Photo #6a

The optional umbrella is supported by two boards. It is easier to attach the umbrella support boards to the seat back before attaching the seat back to the umpire chair.

The top umbrella support board (Part 12) is attached at the back of the seat back (Part 8) on the right and left using two 85mm bolts, washers and nuts (Part A)--one on each end--that go into holes at the ends of the top umbrella support board. See photo #6a. Once attached, it will swivel up and down. See photo #6b.

The bottom umbrella support board (Part 13) is similarly attached at the back of the seat back on the right and left using two 85mm bolts, washers and nuts (Part A)--one on each end--that go into holes at the ends of the bottom board. These holes are located above the two vertically spaced holes that are used to attach the seat back to the seat bottom. See photo #6c.



Photo #6b



Photo #6c

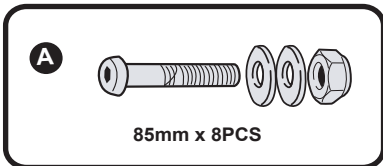

85mm x 8PCS

STEP 7: ATTACH SEAT BACK AND TIGHTEN BOLTS

Attach seat back by sliding it down into slot in seat bottom and aligning the 2 bolt holes at bottom. Attach with 68mm bolts, washers and screws (Part D). Loosely tighten screws by hand only. See drawing #7. After seat back is attached, go back and tighten all bolts and nuts.

STEP 8: ATTACH BACK WHEELS

Attach 2 wheels (Part 16) to back right leg using 125mm rod (Part E), sliding rod through one wheel, washer, leg, washer and other wheel. Attach washer and nut on each end of rod. Repeat for back left leg. Tighten nuts. See drawing #8.

STEP 9: ATTACH FRONT FEET

Attach 2 feet (Part 14) to front right and left legs using 60mm bolts, washers and nuts (Part C). Tighten nuts. See drawing #9.

Drawing #8

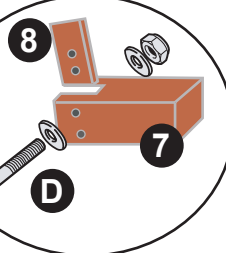
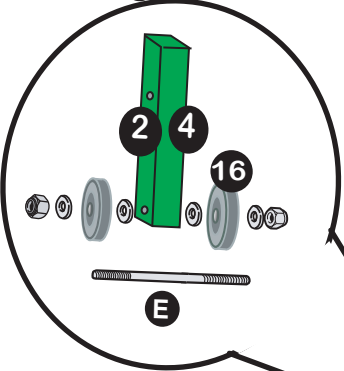

Drawing #7

Drawing #9

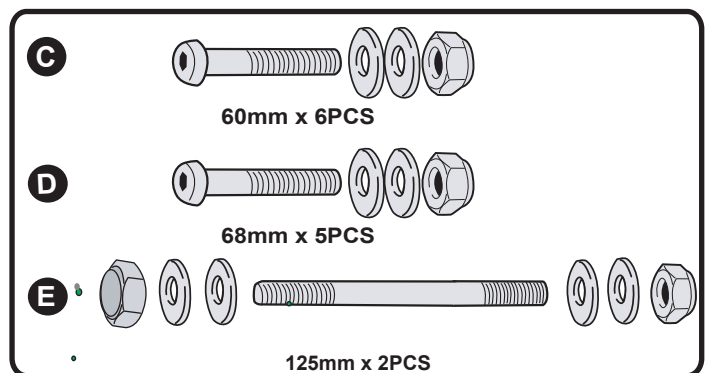
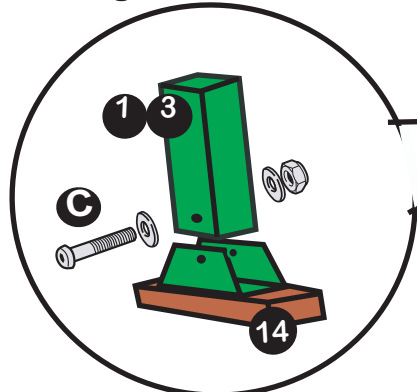

STEP 10—ATTACH WRITING DESK

The writing desk (Part 11) is attached by sliding its bottom runners into the grooves of the arms. See photo #10. *Your umpire chair is complete.*



Photo #10

Ensure all bolts are fastened before use!